



1. Features

- ▶ High Performance
- ▶ High Reliability
- ▶ RoHS Compliant
- ▶ 3GPP/AISG2.0

Triple Band Twin TMA

Part No: RMT1826BY85MAI01

Date: April 3, 2014

Revision No: 00

2. Block Diagram

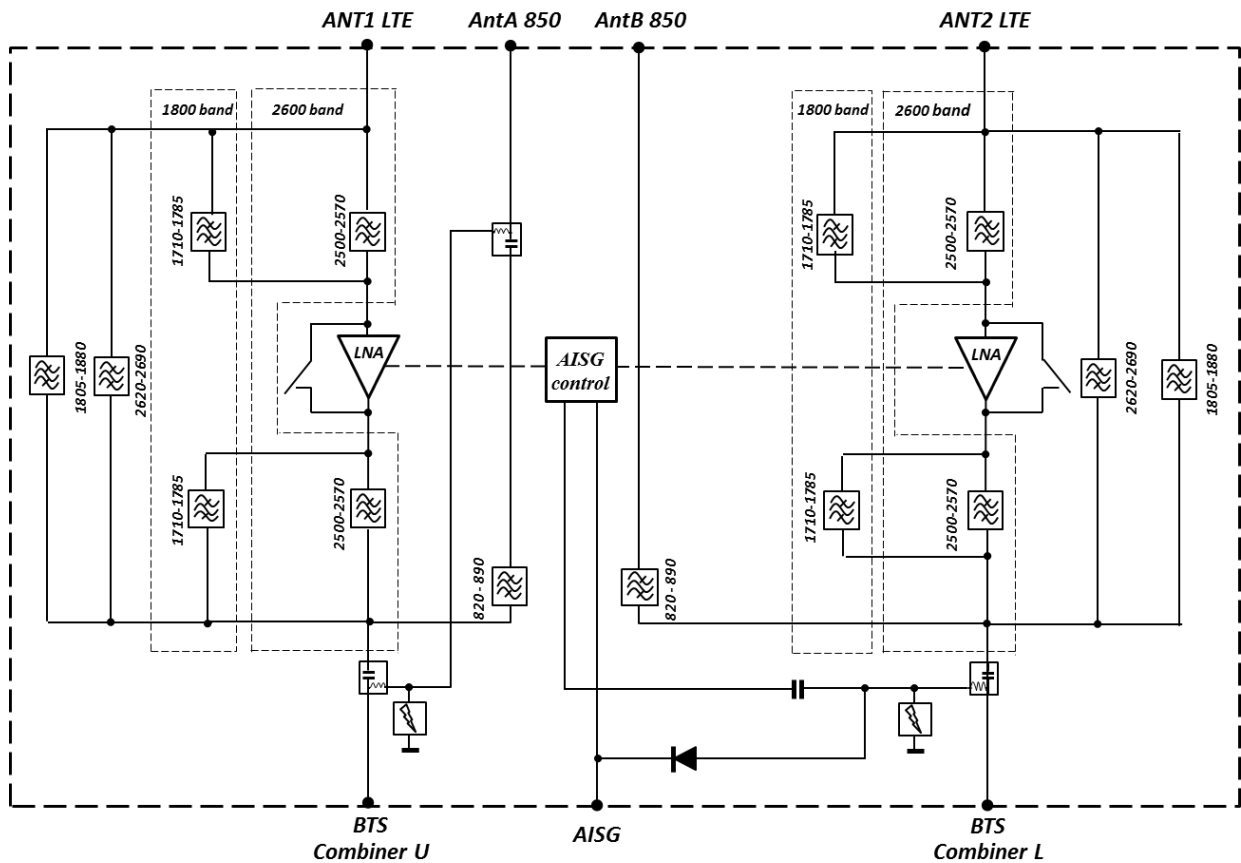



3. Electrical Specifications

Description	Parameter	1800MHz Specification	2600MHz Specification
Uplink	Pass- band, MHz	1710 - 1785	2500 - 2570
	Gain nominal, dB	12±0.5	12±0.5
	Return Loss, dB -Operating -In bypass	18 dB min 12 dB	18 dB min 12 dB
	Noise Figure - typical - maximum	1.4 2.0	1.4 2.0
	Insertion Loss, bypass mode - typical - maximum	2.5 3.2	2.5 3.2
	Output IP3	24dBm min	24dBm min
	Max Input power with no damage	10dBm	10dBm
	Impedance	50 Ohm	
Downlink	Pass- band, MHz	1805 - 1880	2620 - 2690
	Insertion Loss, dB - typical - maximum	0.5 0.7	0.4 0.6
	Return Loss, all ports, dB	18 dB min	18 dB min
	Continuous Average Power (each port)	120W max	120W max
	Peak Envelope Power (each port)	2000W max	2000W max
	Intermodulation @ antenna port in Rx band with 2x20W carriers	-113dBm max (3rd order)	-113dBm max (3th order)
	Impedance	50 Ohm	
Bypass 850 path			
	Parameter	850MHz Specification	Remark
	Pass- band, MHz (at least)	820 - 890	
	Insertion Loss, dB - typical - maximum	0.3 0.5	
	Return Loss, dB	18 dB min	
	Continuous Average Power (each port)	120 W max	
	Peak Envelope Power (each port)	2000 W max	
	Intermodulation @ antenna port in Rx 850 band with 2x20 W carriers	-113dBm (3rd order)	
	Impedance	50 Ohm	



4. Power Supply and Alarm

Parameter	Specification	Remark
DC supply Voltage	10 to 30V DC, case is DC ground	
Compatibility with existing CWA & AISG systems with no additional equipment required;		
Operating current per unit	CWA mode: 150mA (Normal)/220mA (Alarm)	
BTS Combiner L" input	per port (300mA (Normal) total);	
(without RET)	AISG mode: 265mA @7.5V / 220mA @30V – Port with AISG packets;	
Alarm protocol	3GPP/AISG 2.0	

5. Mechanical Specifications

Parameter	Specification	Remark
Size (maximal)*, mm	215.0 x 350.0 x 163.0mm	Include Bracket
Weight (maximal), kg	Around: 13.5Kg	
RF connectors	6x DIN 7/16 F, long neck	
AISG connector	8-pin female, IEC 60130-9	
Mounting	Pole/Wall	
Application	Outdoor IP67	
Marking	As it shown at out drawing	

6. Environmental Data

Parameter	Specification	Remark
Operating temperature range	-10°C to +60°C	
Humidity	95% RH	
Lightning Protection	5kA (8/20 us) RF ports, 2kA (8/20us) AISG port	
MTBF	> 500,000 hours	
Splash, Dust	according to IP67	



7. Outline Drawing

